

# **Sandblast Booth**

## **PARS2000 Pneumatic Recovery System with Vacuum Head**

### **Instruction Manual**



*Revision: December 2<sup>nd</sup>, 2025*

---

**Kresco**

Address: 1404, avenue de la Gare, Mascouche, QC J7K 2Z2

Telephone: (877) 757-3726 • Email: [info@krescosolutions.com](mailto:info@krescosolutions.com) • Website: [krescosolutions.com](http://krescosolutions.com)

# TABLE OF CONTENTS

GENERAL SAFETY RULES.....	3
EQUIPMENT OVERVIEW.....	4
OPERATING PRINCIPLE .....	4
VENTILATION.....	5
AIR INLET AND OUTLET PLENUMS.....	6
CYCLONIC SEPARATOR.....	7
ADJUSTING THE CYCLONIC SEPARATOR.....	8
ADJUSTING THE 2" SBR 1/8" RUBBER BAND .....	8
ADJUSTING THE TELESCOPIC TUBE INSIDE THE RECLAIMER.....	9
REMOTE-CONTROL BOX.....	10
PRESSURIZATION/DEPRESSURIZATION SWITCH.....	10
SANDBLASTING/AIR ONLY SWITCH .....	10
CONTROL PANEL.....	11
MAIN MENU (AUTOMATIC MODE).....	11
OTHER MENU OPTIONS.....	12
ALARMS MENU .....	13
MANUAL MENU.....	14
MENU SETTINGS .....	15
START-UP PROCEDURE.....	16
ADDITION OF ABRASIVE MEDIA.....	16
SYSTEM OPERATION.....	17
SYSTEM SHUTDOWN .....	20
PREVENTIVE MAINTENANCE.....	21
SANDBLAST BOOTH.....	21
SANDBLASTING EQUIPMENT .....	22
PARS5000 DUST COLLECTOR.....	23
VACUUM HEAD.....	25
TROUBLESHOOTING.....	26
TROUBLESHOOTING THE DUST COLLECTOR OF THE PNEUMATIC RECOVERY SYSTEM.....	26
WARRANTY STATEMENT.....	30
ABOUT KRESCO .....	31

## GENERAL SAFETY RULES

### DANGER AND WARNING LABELS

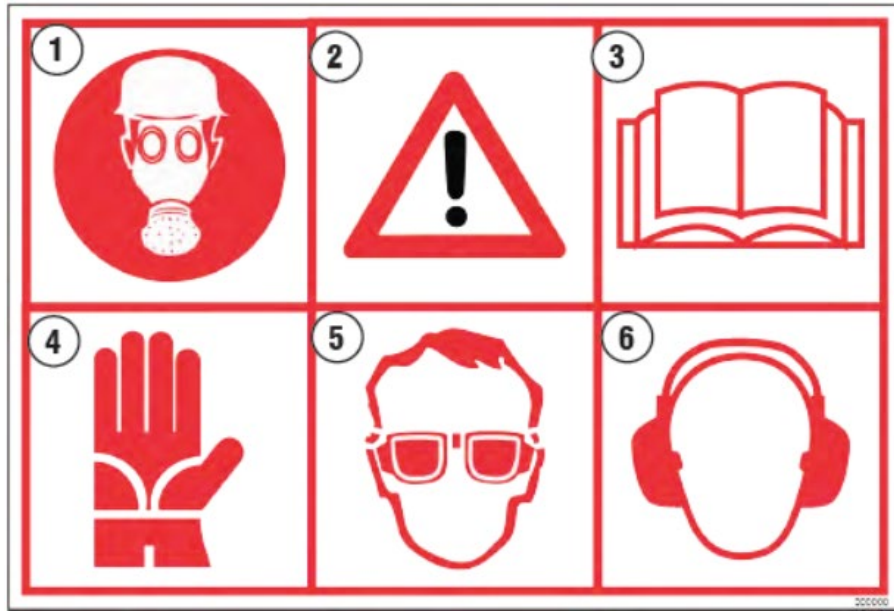

1. Wear a respiratory mask
2. Observe the security warnings at all times
3. Read the instruction manual carefully.
4. Wear safety gloves
5. Wear safety glasses before use
6. Wear hearing protection before use

### WARNINGS

Please read the User Manual and all other safety instructions carefully before using this equipment. Failure to follow the SAFETY RULES and other precautions described in this document may result in serious injury.

### WARNINGS

Sandblasting equipment can emit potentially hazardous dust and airborne contaminants during operation. Appropriate respiratory protection must be worn at all times when operating or near the equipment.

## EQUIPMENT OVERVIEW

### OPERATING PRINCIPLE

The PARS5000 Abrasive Recovery System with vacuum head for sandblasting booth is a high-performance and efficient solution for recovering abrasive accumulated in compartments that are difficult to tip over (which would normally be handled by recovery systems with floor pits).

This system features a powerful cartridge dust collector with a high-efficiency turbine (PARS5000) and a vacuum head that allows for the extraction of abrasive media from the compartments. The contaminated abrasive is then cleaned by a Cyclonic Separator and returned to the sandblast pot for subsequent use.

It supports the majority of light or heavy abrasive media available on the market.

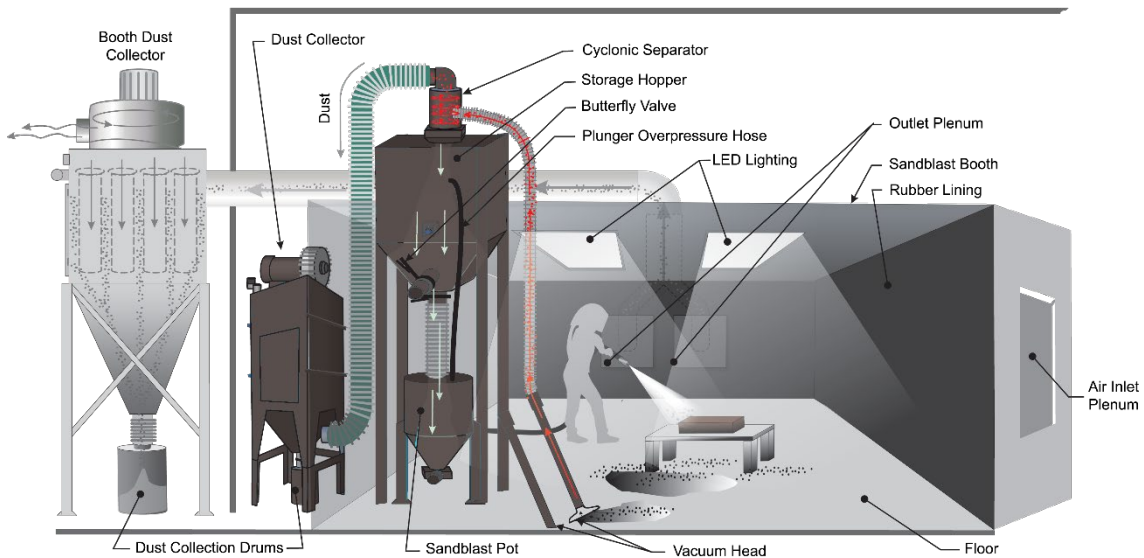

## VENTILATION

The ventilation of the booth is created by means of a powerful fan mounted on a dust collector which sucks up the air contaminated with dust and airborne contaminants from the booth.

The fan and suction ducts are calibrated according to the booth dimensions to achieve a negative pressure of 1/2" wg (Nominal) at the end of the room.

This configuration draws in outside air through the air inlet plenums located at the opposite end of the booth and creates a cross-flow of air through the booth which provides ventilated air and increase visibility inside during sandblast operation.

The outlet plenums allow dust-laden air to be directed to the sandblast booth dust collector. The inlets and outlets are proportioned to ensure adequate air volume and flow rates.

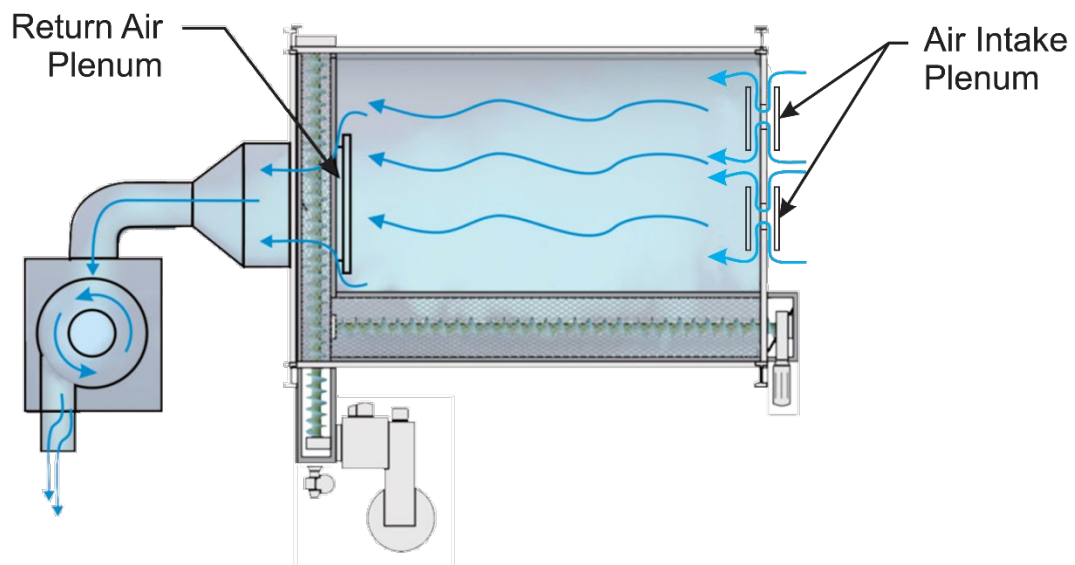

## AIR INLET AND OUTLET PLENUMS

Different inlet and outlet plenum configurations are available depending on the booth parameters and product loading door type.

Inlet plenums are typically installed on product loading doors while outlet plenums are located at the opposite end (on the booth wall in the case of single-exit chambers and around the unloading doors for a 'Drive-Thru' type booth).

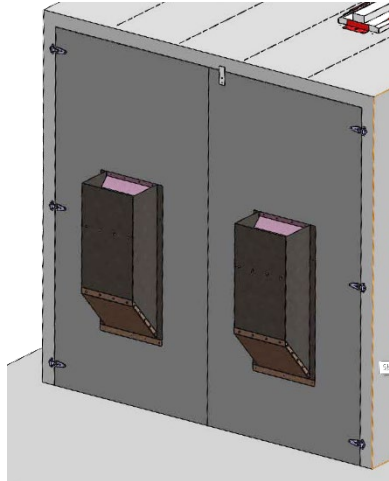

Air intake plenums

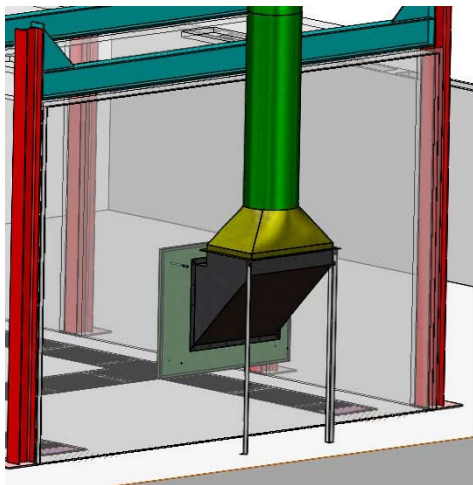

Outlet plenum of a 'Solid Back' type booth

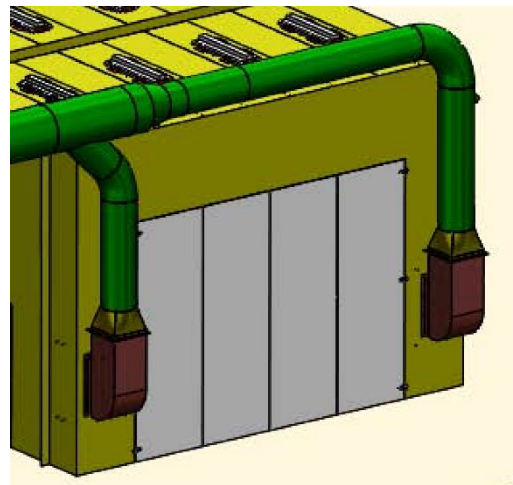

Outlet plenums of a 'Drive-Thru' type booth

## CYCLONIC SEPARATOR

Cleaning and recycling of the abrasive media is possible thanks to the Cyclonic Separator located on top of the sandblasting pot assembly and its recovery hopper.

The Cyclonic Separator, also known as the Abrasive Media Reclaimer, cleans the abrasive media circulating through your Sandblast Booths by separating improperly sized particulates from the abrasive media mix using a centrifugal motion.

The velocity of the centrifugal airflow can be adjusted by means of openings partially covered by a rubber strip. The circular movement of the contaminated media separates the good media from the process by-products (paint chips, rust, dust, broken media, etc.) based on particle density.

Thus, dust and fine particles are diverted to the dust collector while the media in good working order is returned to the sandblasting pot for continuous looped use.

An optional rubber coating is available to protect the integrity of the separator against abrasion from particularly sharp media.

A debris drawer with a wire mesh floor captures large pieces (hardware, wood particles, etc.) to prevent them from entering sensitive system components such as valves and the sandblasting nozzle.

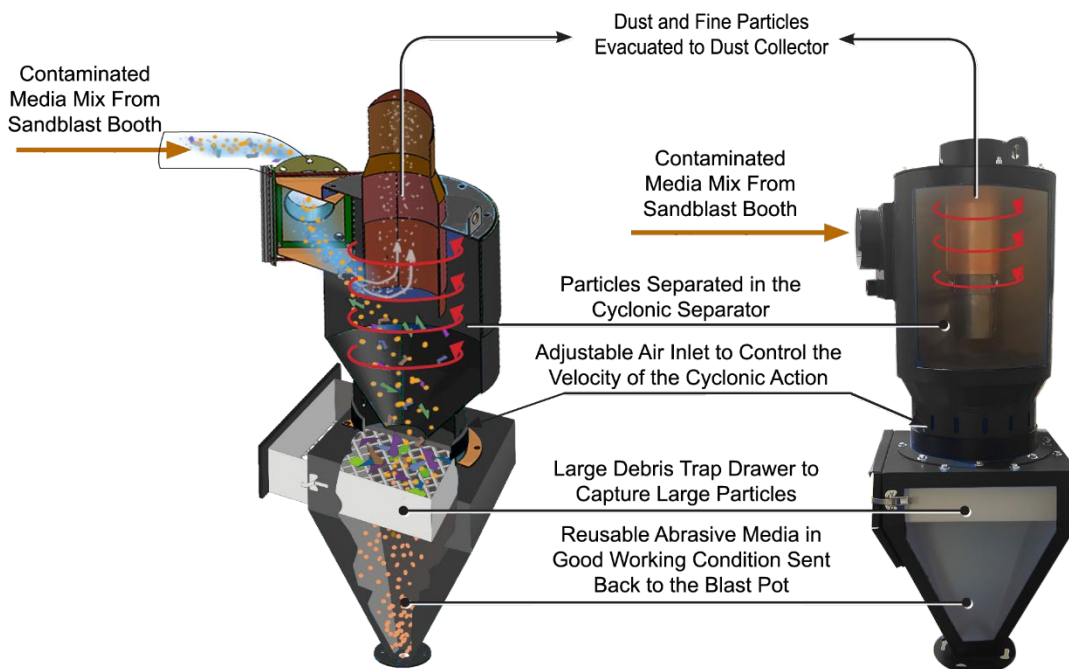

## ADJUSTING THE CYCLONIC SEPARATOR

Although the Cyclonic Separator arrives factory set based on the Abrasive Media declared when purchasing your Sandblast Booth Abrasive Media Recovery System, it is possible and advised to perform some minor adjustments on site to optimize the cleaning efficiency of your Abrasive Media, thus the overall performance of your process.

Furthermore, it is necessary to adjust the Cyclonic Separator each time you change Abrasive Media type or mesh size.

### ADJUSTING THE 2" SBR 1/8" RUBBER BAND

The 2" SBR 1/8" Rubber Band is used to partially cover the holes located around the Separator body to control the airflow speed inside the Cyclonic Separator.

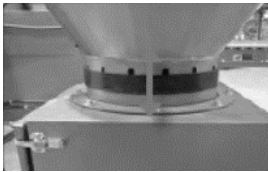

- Covering the holes slows down the motion speed, letting particles of smaller density fall down the Cyclonic Separator back to the Sandblast Cabinet Storage Hopper
- Uncovering the holes increases the motion speed, exhausting particles of bigger density to the Dust Collector

A velocity that is too slow for the Abrasive Media will result in a dusty media mix (incapacity of efficiently exhausting dust and fine particles to the Dust Collector; while a velocity that is too fast will draw Abrasive Media in good condition to the Dust Collector).

A properly adjusted motion speed will draw only dust and fine particles away, returning only good media back to the Storage Hopper for further use.

Follow these steps to adjust the 2" SBR 1/8" Rubber Band to the correct location:

1. WHEN YOU START YOUR EQUIPMENT FOR THE FIRST TIME, we recommend leaving all orifices covered to try recycling without interfering with the basic setup of the ventilation system
2. Sandblast for at least 4-8 hours in normal process conditions to allow the system to start sorting out particles with the new adjustment
3. Observe both the material being collected in the Dust Collector waste drum and the quality of Abrasive Media circulating through the cabinet
4. If the Abrasive Media seems dusty or inefficient, lower the 2" SBR 1/8" Rubber Band approximately 1/4" to let a small quantity of air entering the Cyclonic Separator which will accelerate the velocity of the vortex
5. If the Dust Collector waste drum collects Abrasive Media that looks in good condition and/or if you notice that the level of Abrasive Media circulating in the cabinet has lowered significantly, move up the 2" SBR 1/8" Rubber Band approximately 1/4" to slightly cover the orifices which will decelerate the velocity of the vortex
6. Empty the Dust Collector dust drum
7. Sandblast for at least 4-8 hours in normal process conditions to allow the system to start sorting out particles with the new adjustment and then repeat Steps 3 to 8 until the correct adjustment has been obtained

**ALLOW APPROXIMATELY FOUR (4) HOURS OF SANDBLASTING OPERATIONS BETWEEN EACH ADJUSTMENT** to notice the difference as the Abrasive Media mix must circulate a few times through the Cyclonic Separator so the new adjustment takes effect. Do minor adjustments each time. It can take a few routines before the correct vortex motion speed is obtained.

## **ADJUSTING THE TELESCOPIC TUBE INSIDE THE RECLAIMER**

If the adjustment of the 2" SBR 1/8" Rubber Band has been proven inefficient to obtain a proper particle separation or in the event that the Abrasive Media type or mesh size is changed from the initial process, the adjustment of the Telescopic Tube is necessary.

The Telescopic Tube is positioned in such a way to capture the Abrasive Media mix circulating in the centrifugal motion at the right location near the Storage Hopper.

The bottom of the Telescopic Tube sucks in particles and forces them out through the outlet located on the top of the Cyclonic Separator.



- The lower the Telescopic Tube, the higher volume of Abrasive Media mix is sucked and exhausted to the Dust Collector
- The higher the Telescopic Tube, the less volume of Abrasive Media mix is sucked and exhausted to the Dust Collector

**NOTE:** The adjustment of the Telescopic Tube inside the reclaimer must be performed by or under the supervision of an experienced **Kresco** Technical Representative.

Follow these steps to adjust the Telescopic Tube to the correct location:

1. Move the Telescopic Tube up or down (depending on the desired output) 1" at the time.
2. Sandblast for approximately four (4) hours, and observe both the quality of the Abrasive Media inside the Storage Hopper and the dust collected inside the Dust Collector drum.
3. If necessary, empty the dust collection drum and repeat Steps 1 and 2 above until the correct position is obtained.

**ALLOW APPROXIMATELY FOUR (4) HOURS OF SANDBLASTING OPERATIONS BETWEEN EACH ADJUSTMENT** to notice the difference as the Abrasive Media mix must circulate a few times through the Cyclonic Separator so the new adjustment takes effect.

## REMOTE-CONTROL BOX

A remote-control unit located inside the sandblast booth allows the operator to control certain valves of the blast pot from inside the chamber using a switch, without having to remove their personal protective equipment (PPE).

### PRESSURIZATION/DEPRESSURIZATION SWITCH

The pressurization/depressurization switch allows the operator to depressurize the pressurized vessel of the blasting pot in order to fill its reservoir.

This switch controls the AV-176 combo air valve to release pressure inside the blasting pot, allowing the plunger to fall and letting the abrasive contained in the storage hopper fill the vessel.

### SANDBLASTING/AIR ONLY SWITCH

The sandblasting/air only switch allows control of the opening and closing of the media regulating valve.

The 'air only' position of this switch allows the sandblasting line to be transformed into a powerful blower producing high-velocity compressed air that can be used to blow dust off of the freshly sandblasted parts or to blow abrasive residue into excavated recovery pits.



## CONTROL PANEL

Sandblasting chambers equipped with a Kresco recovery system come with a control panel featuring a touchscreen user interface to control the main functions.

### MAIN MENU (AUTOMATIC MODE)

The main menu is the main screen that appears when the control panel is opened.

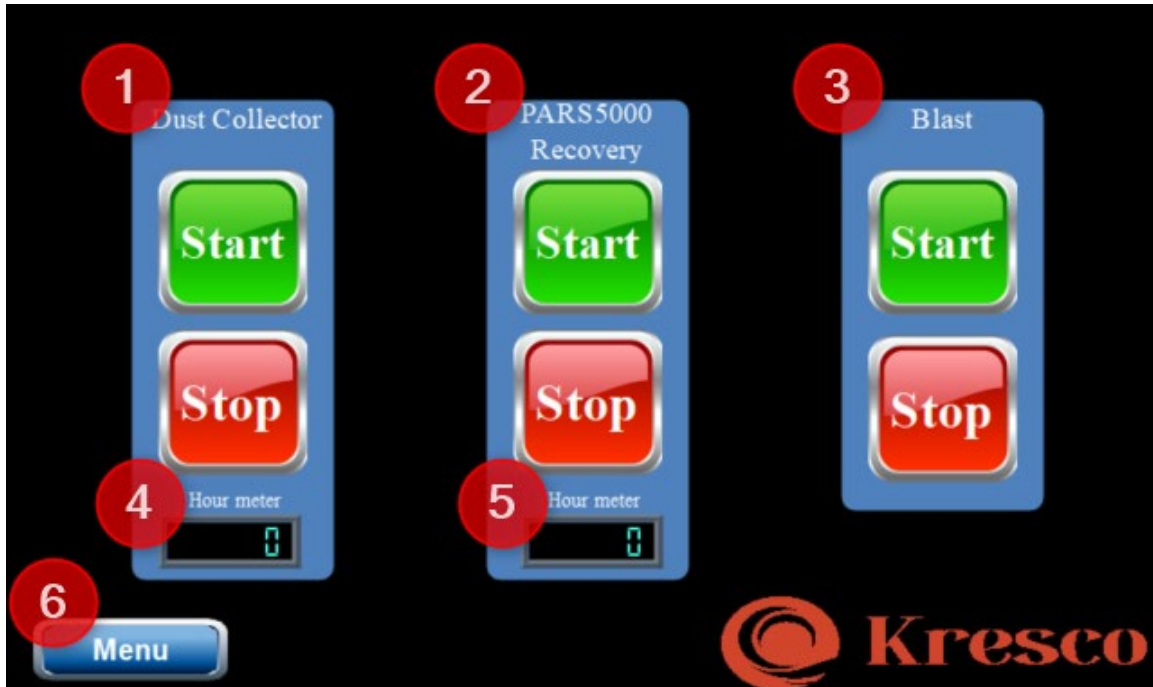

This is a simple user interface that allows the operator to control basic system parameters, including:

1. Start/Stop the booth dust collector
2. Start/Stop the PARS5000 recovery system dust collector
3. Start/Stop the sandblasting system
4. Display the booth dust collector's operating hours
5. Display the recovery system's operating hours count
6. Access other menu options

## OTHER MENU OPTIONS



The different menu options are:

1. **Automatic**- Access the main screen in automatic mode
2. **Alarms**- Access the Alarms page
3. **Manual\***- Access the Manual Mode page which allows you to operate each piece of equipment individually
4. **Settings\***- Access the system configuration page

Menus marked with an asterisk (\*) are password protected. To access them, the operator must log in as an administrative user.

## ALARMS MENU

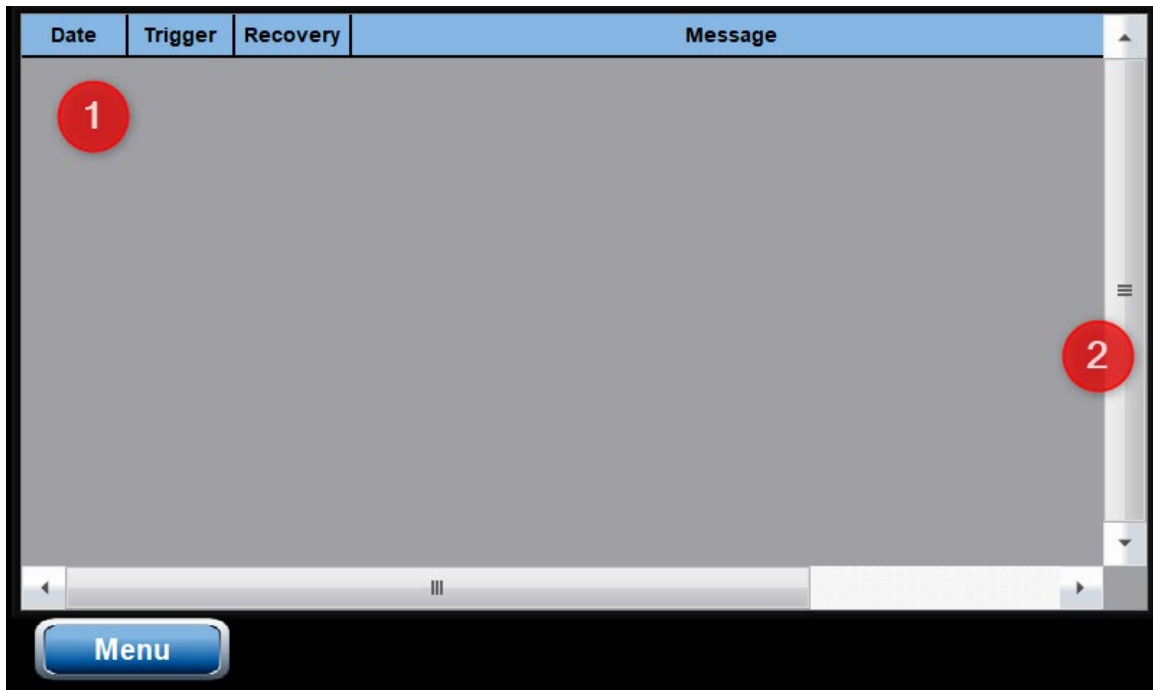

The Alarms menu options are:

1. Displaying current alarms (in red) as well as resolved alarms (in green).
2. The arrows allow you to scroll through the alarm history.

## MANUAL MENU

The Manual menu allows maintenance personnel to operate each system individually for maintenance or verification purposes.

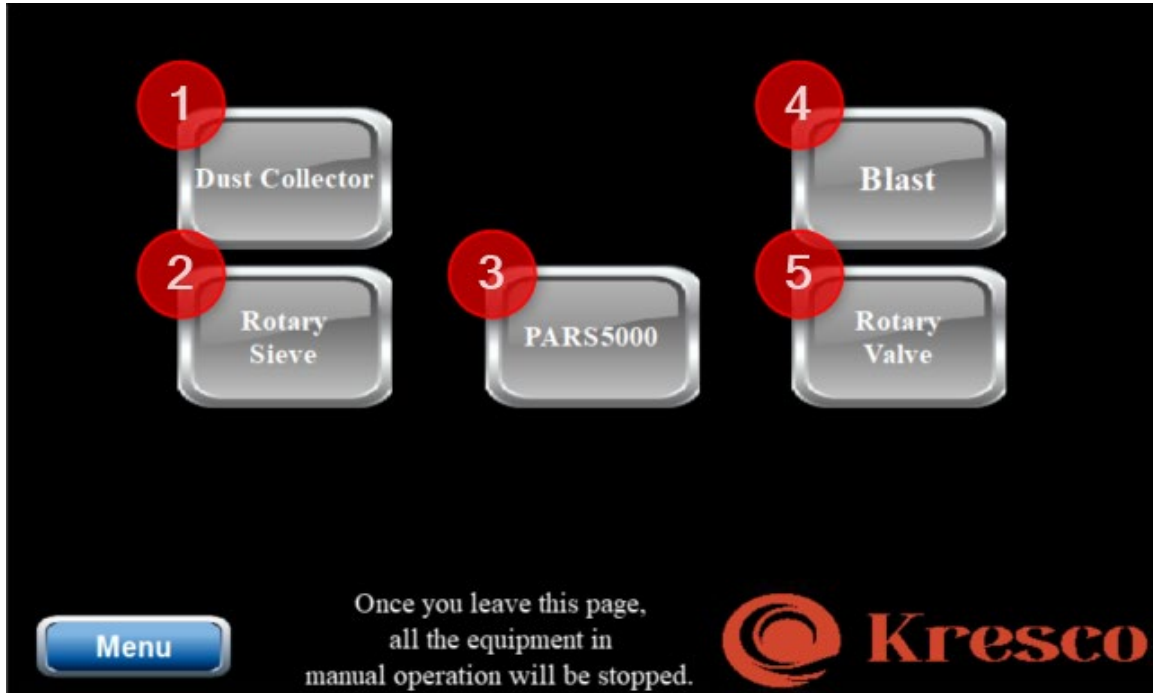

To activate a component in manual mode, press the component for 3 seconds until the button changes from grey to green.

1. Start/Stop the booth dust collector
2. Start/Stop the rotary sieve
3. Start/Stop the PARS5000 recovery system dust collector
4. Start/Stop the sandblasting system
5. Start/Stop the rotary valve

All components currently in operation will cease to function upon exiting the Manual menu.

## MENU SETTINGS

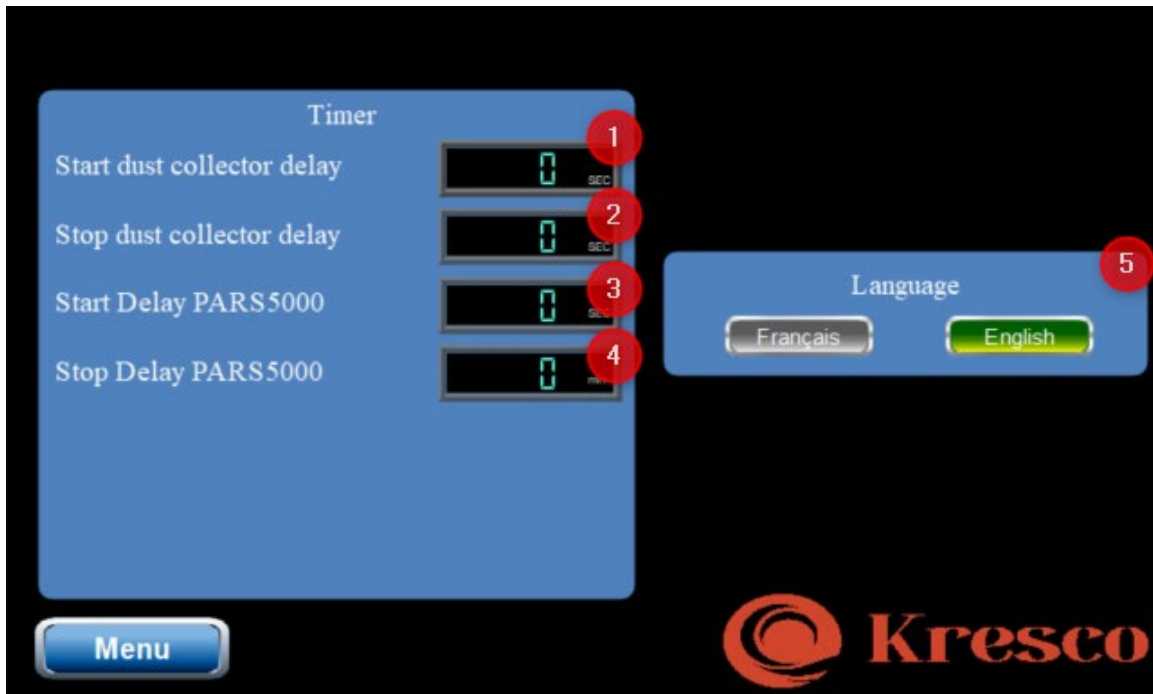

The Settings menu allows you to modify certain basic system settings, including:

1. Modify the booth dust collector start-up delay
2. Modify the booth dust collector stop delay
3. Modify the PARS5000 recovery system dust collector start-up delay
4. Modify the PARS5000 recovery system dust collector stop delay
5. Change the menu display language

### WARNINGS

The system startup and shutdown times are factory-set by Kresco technicians. It is not recommended to alter these settings to avoid irreversible damage to your system unless specifically instructed to do so by a Kresco representative.

## START-UP PROCEDURE

### ADDITION OF ABRASIVE MEDIA

Follow the procedures below to add abrasive media to the system:

1. Start the room dust collector
2. Start the recovery system
3. Pressurize the sandblasting pot
4. Empty the media onto the floor and vacuum it up using the vacuum head (if necessary, disconnect the hose from the vacuum and vacuum directly with the hose to increase the speed).
5. Stop adding media when the system detects that there is enough media and the 'High-Level Media' alarm triggers. At this point, the PARS5000 recovery system dust collector will stop working.
6. Depressurize the sandblast pot to transfer the media from the storage hopper to the sandblast pot.
7. Reset the High-Level alarm and restart the recovery system to vacuum up the remaining media from the floor.

### WARNINGS

To prevent overloading the pneumatic recovery system, a level sensor is installed on the storage hopper (optional on some hoppers).

When the hopper level sensor is triggered, the PARS500 recovery system dust collector will stop operating.

The maximum volume of abrasive media added to the system should correspond to the capacity of the storage hopper plus that of the sandblasting pot.

## SYSTEM OPERATION

From the control panel:

1. Start the booth dust collector ①.
2. Start the sandblasting system ③.
3. Turn on the bedroom lights.

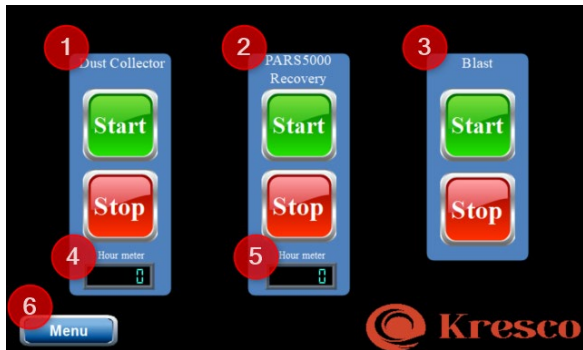

From the air intake manifold:

4. Open the ball valve at the air inlet.
5. Adjust the working pressure to the desired pressure.

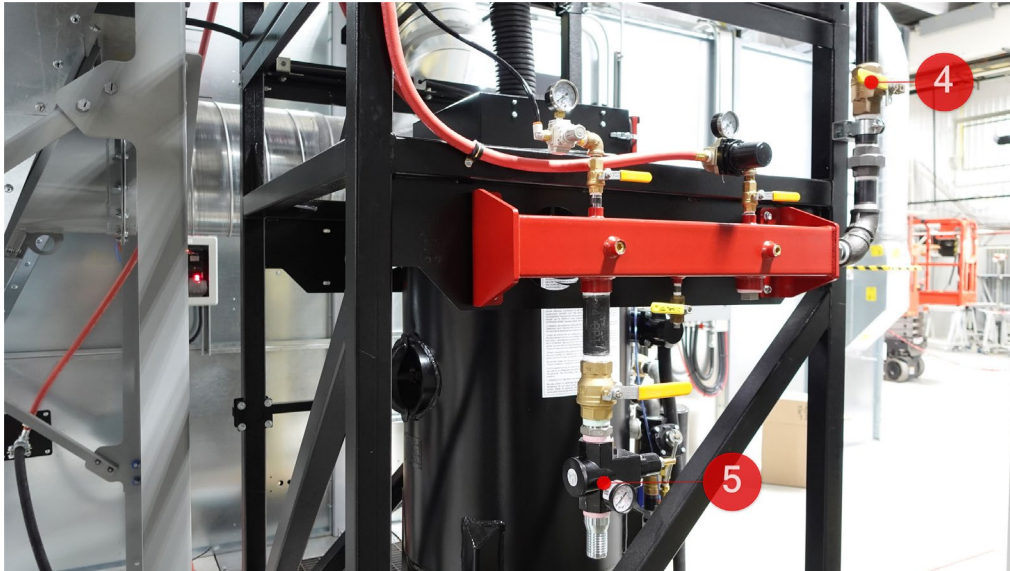

Before entering the sandblasting booth:

6. Inspect the sandblast pot and air breathing filtration system to ensure that no failures, leaks or breakages could impair system operation or endanger the operator's life.
7. Put on appropriate personal protective equipment (PPE).



Before starting the sandblasting operations:

8. Ensure that all doors to the sandblasting chamber are closed and that the door opening detectors are not in alarm.
9. Pressurize your sandblast pot:
  - a. If your system has a remote-control box: Position the Pressurization/Depressurization switch in the 'Pressurization' position.
  - b. If your system does not have the remote-control unit: Close the exhaust ball valve and open the air intake ball valve on the pot.
10. If your system has the remote-control box: Position the Sandblasting/Air Only switch in the 'Sandblasting' position.

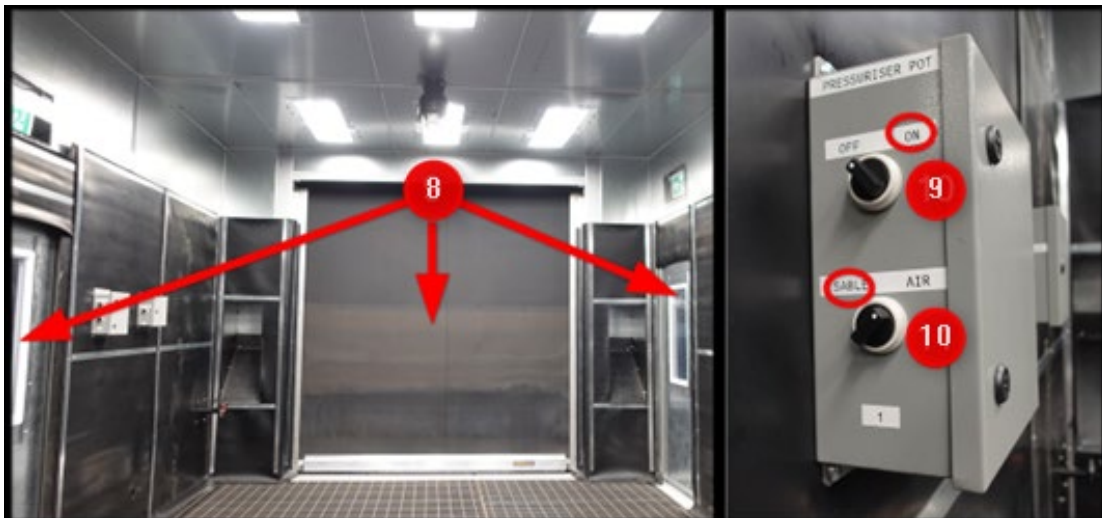

11. Install the parts to be sandblasted in the center of the booth to avoid projecting the abrasive media towards the doors or control systems.
12. Position the sandblasting hose to avoid sharp bends as much as possible (they risk damaging and prematurely wear the hose).
13. Check that the nozzle is screwed on securely and that the connections are airtight.



**Congratulations! You are now ready to begin the sandblasting operations.**

Useful advices during sandblasting:

14. Position the sandblasting hose on your shoulder, holding the hose firmly near the control handle.
15. Press the control handle to begin sandblasting. **Be aware of the inertia created by the launch of the abrasive jet.**
16. Wait a few seconds for the jet to stabilize. If necessary, adjust the media regulation valve following the procedure described in your sandblasting pot manual to obtain the optimal jet.
17. Release the control handle when moving or repositioning.
18. Gently place the nozzle on the ground. **Do not throw it abruptly as it may break.**

When the blast pot is empty of material:

19. Depressurize your sandblast pot:
  - a. If your system is equipped with a remote-control unit: Position the Pressurization/Depressurization switch in the 'Depressurization' position. **Be aware of the high-pitched noise that will escape through the depressurization valve.**
  - b. If your system does not have the remote-control box: Close the air intake ball valve on the pot and open the exhaust ball valve.
20. Wait approximately three (3) to five (5) minutes to allow time for the vessel to fill.
21. Pressurize your sandblasting pot:
  - a. If your system has a remote-control box: Position the Pressurization/Depressurization switch in the 'Pressurization' position.
  - b. If your system does not have the remote-control unit: Close the exhaust ball valve and open the air intake ball valve on the pot.
22. Wait about ten seconds to allow the hose to depressurize.
23. Resume sandblasting operations normally.

Following the sandblasting operations:

24. Depressurize your sandblasting pot:
  - a. If your system is equipped with a remote-control unit: Position the Pressurization/Depressurization switch in the 'Depressurization' position. **Be aware of the high-pitched noise that will escape through the depressurization valve.**
  - b. If your system does not have the remote-control box: Close the air intake ball valve on the pot and open the exhaust ball valve.
25. If your system is equipped with the remote-control unit:
  - a. Position the Sandblasting/Air Only switch in the 'Air Only' position.
  - b. Press the control handle to use the sandblasting hose as a powerful blower to clean parts.
26. Start the PARS5000 recovery system ②.
27. Vacuum up abrasive media residue using the vacuum head.

## SYSTEM SHUTDOWN

### WARNINGS

Before opening the booth doors and stopping the dust collector, wait 2 minutes inside the booth after all sandblasting, floor cleaning and room cleaning operations are completed to allow the booth dust collector to properly remove suspended dust.

From the control panel:

1. Turn off the booth lights
2. Stop the sandblasting
3. Stop the recovery system
4. Stop the booth dust collector

# PREVENTIVE MAINTENANCE

## SANDBLAST BOOTH



### WEEKLY MAINTENANCE ROUTINE

Component	Additional information
Rubber coating	→ Check the rubber coating for wear or deterioration ① and replace it if necessary.
Lighting system	→ Clean the Lexan light protector frequently ③ and replace when necessary.
Staff entrance	→ Clean the Lexan window of the door frequently ⑤ and replace when necessary. → Make sure the door seal ⑥ is airtight and replace when necessary.

### REPLACE WHEN NECESSARY

#	Kresco Code	Description
1	RUR-SBR-1/8X48-BLK	1/8" black SBR rubber, 48" Wide (sold by foot)
2	SBBOP-DOOR-SWITCH	Safety Switch
3	LEX-CH-0001	Clear Lexan for LED fixture for sandblasting booth 18" wide x 47" long x 1/8"
4	LIG-FL-120V-45WH-1800	Fixture light 120-277V 45" Long 18,000 Lumen
5	LEX-PL15-3/4X32-3/4X1/16	Protector for Lexan 15-3/4" wide x 32-3/4" long x 1/16" thick
6	ROL-NO1X1-S-ME	Open-cell polyester urethane foam, 1" width x 1" thickness

## SANDBLASTING EQUIPMENT



### DAILY MAINTENANCE ROUTINE

Component	Additional information
Personal protective equipment (PPE)	→ Inspect the personal protective equipment ①. Maintain or replace as needed.
Sandblasting hose	→ Position the sandblasting hose ② in a way to avoid overlaps and overly sharp curves.

### WEEKLY MAINTENANCE ROUTINE

Component	Additional information
Remote-control handle	→ Inspect and maintain the remote-control handle ⑤.
Sandblasting hose	→ Inspect the sandblasting hose ②. Look for signs of wear or leakage and replace if necessary.
Sandblasting nozzle	→ Inspect the sandblasting nozzle ③ and replace when required.
'Whip' section of the sandblasting hose	→ Inspect the 'whip' hose ④ for leaks and replace when necessary. The "whip" hose has a thinner wall for easier handling but wears out more quickly than regular sandblast hose.

### MONTHLY MAINTENANCE

Component	Additional information
Sandblasting 'push' line	→ Inspect the sandblasting hose ②, the fittings and their sealing gaskets ⑥ for signs of premature wear or leakage. → Replace them if necessary.
Personal protective equipment (PPE)	→ Inspect the breathing air supply hose ⑦ fittings and seals for weak points and premature wear. → Replace them if necessary.

## PARS5000 DUST COLLECTOR



### WEEKLY MAINTENANCE ROUTINE

Component	Additional information
Pulse controller	<ul style="list-style-type: none"> <li>→ Check the static pressure differential indicated on the dial ④.</li> <li>→ Replace the cartridges ⑤ when the value remains above 2 WC.</li> </ul>
Dust drum	<ul style="list-style-type: none"> <li>→ Empty the dust drum regularly ⑦.</li> <li>→ Check the condition of the particles inside: if good media is present, refer to the troubleshooting chart to remedy the situation.</li> </ul>

### MONTHLY MAINTENANCE

Component	Additional information
Dust collector	<ul style="list-style-type: none"> <li>→ Inspect the dust convey hose ⑥ and its connections to the system to detect leaks (audible noise).</li> <li>→ Make sure the dust drum connection ⑦ is airtight at all time.</li> <li>→ Check the inline filter located at the air intake of the dust collector.</li> <li>→ Replace any leaking or defective parts.</li> </ul>
Door seal	<ul style="list-style-type: none"> <li>→ Inspect the service door seals ③.</li> <li>→ Replace it if necessary.</li> </ul>
Impulse valve (Goyen)	<ul style="list-style-type: none"> <li>→ Check the pressure gauge ② to ensure that the pressure is set to 80 PSI.</li> <li>→ Adjust it as needed.</li> </ul>

## BI-ANNUAL MAINTENANCE

Component	Additional information
Motor	<ul style="list-style-type: none"> <li>→ Check the motor rotation ① for signs of squeaking, imbalances or vibrations.</li> <li>→ Maintain it or replace it as needed.</li> </ul>
Pulse controller	<ul style="list-style-type: none"> <li>→ Inspect and clean or replace the static pressure sampling filter ④ installed on the dirty side of the cartridges (at the end of the red air hose).</li> </ul>
Cartridges	<ul style="list-style-type: none"> <li>→ Check the reading on the differential pressure gauge located on the pulse controller ④.</li> <li>→ Replace the cartridges ⑤ when necessary</li> <li>→ Refer to the section <b>BASIC PRINCIPLE OF THE CARTRIDGE CLEANING SYSTEM</b> for more information.</li> </ul>

## REPLACE IF NECESSARY

#	Kresco Code	Description
1	MOT-BL-900-27	Regenerative Blower 15kW 3PH 60Hz 575V
2	VAV-DIAP-1X1/4-PNE	Diaphragm Valve 1" Dresser Nut 1/4" NPTF Pilot Port
3	ROL-D3/4X17/32-S	Foam Neoprene Type D 3/4" X 17/32" Adhesive
4	FLT-1/8MX1/8F	In-Line Filter 1/8" NPTM X 1/8" NPTF
5	FILT-CM318-85/15-MERV11	Filtering Cartridge 85/15, Filtering Area 318 sq.ft., MERV 11, 12-3/4" Dia. X 36" Long
6	FLX-UFD6-CLR	Polyurethane Hose UFD 6" Clear

## VACUUM HEAD



## INTERVIEW

Component	Additional information
Vacuum Head Kit	<ul style="list-style-type: none"> <li>→ Do not allow the media to accumulate in the vacuum cleaner hose. ② in order to avoid blocking it.</li> <li>→ Avoid abruptly bending the hose ②.</li> </ul>
Rotating barrel	<ul style="list-style-type: none"> <li>→ Empty the debris bucket ⑤ located at the bottom of the rotating barrel regularly.</li> <li>→ Grease the rotating barrel motor ⑥ about twice a year.</li> </ul>

## REPLACE IF NECESSARY

#	Kresco Code	Description
1	SEN-MLS-LVL	Media Level Switch 24VDC 1.25" NPT
2	FLX-POL-3	Polyurethane Hose 3"
3	COU-BCAM3X3NPTF-ALU	Coupling Camlock 3" Coupler x 3" Hose Shank Aluminum
	COU-BCAM3X3-ALU	Quick Coupling Camlock 3" Coupler x 3" Hose Shank, Double Lock, Aluminum
4	Q2024-211-2200	Vacuum Head Kit (Complete Assembly)

## TROUBLESHOOTING

### TROUBLESHOOTING THE DUST COLLECTOR OF THE PNEUMATIC RECOVERY SYSTEM

Type of failure	Possible cause	Resolution
The fan does not start	Inadequate power supply	Check the fuses when the circuit is off.
Excessive dust in the sandblasting booth (poor visibility)	Non-recyclable abrasive <sup>1</sup>	Drain the non-recyclable media from the recovery system and replace it with recyclable abrasive media.
	Poor adjustment of the air intake and outlet plenums	Contact your Kresco representative
	Cartridge partially or completely blocked	Empty the dust container located under the dust collector. Check and replace the cartridge if necessary (Note: cartridges should never be cleaned with water).
	Dust collector motor connected backwards (the turbine rotates in the wrong direction, blowing air into the sandblasting booth rather than the other way around)	Contact an electrician and check the motor's electrical connection.
	Incorrect adjustment of the 1/8" x 2" SBR elastic band on the cyclone separator. The openings are partially or completely blocked, reducing the velocity inside the cyclone separator and preventing efficient dust removal.	Follow the procedures for <b>ADJUSTING THE 2" SBR 1/8" RUBBER BAND</b> and gradually clear the holes to increase air velocity. NOTE: If the abrasive media has changed since the first use of the sandblasting cabinet, contact a Kresco technician for proper adjustments.
The ventilation system is working, but the sandblasting is not.	The Pressurization/Depressurization switch is in the 'Depressurization' position.	Return it to the 'Pressurization' position
	The door security system is in alarm.	Make sure all the doors in the room are closed.
	There is a problem related to the control of the pressurized vessel.	Refer to the sandblasting pot manual to resolve the issue.

<sup>1</sup>Never use non-recyclable abrasives in Kresco sandblast booths, such as silica sand, recycled glass, or similar materials. Kresco recovery systems are designed for use exclusively with low-dust, recyclable media. For more information, contact your Kresco technical representative.

Type of failure	Possible cause	Resolution
The abrasive is not sucked up and returned to the storage hopper.	Poor electrical connection	Check the fan rotation
	Clogging of the recovery system	Clean any obstructions in the elbow at the outlet of the transfer hopper.
	Cartridge partially or completely blocked	Empty the dust drum located under the dust collector. Check and replace the cartridge if necessary (Note: cartridges should never be cleaned with water).
	Incorrect adjustment of the guillotine valve at the fan outlet.	Ensure that the flap that controls the airflow coming out of the fan is properly adjusted.
The abrasive media in good working condition ends up in the dust collector's dust drum (too much velocity (cfm) in the Cyclonic Separator)	Undesirable air intake in the recovery system	Ensure there are no leaks in the pipes or hoses carrying the abrasive. Check the seal between the pressurized vessel and the cyclone system.
	Incorrect adjustment of the 2" SBR 1/8" rubber band on the Cyclonic Separator. The openings are partially or completely uncovered, increasing the velocity inside the Cyclonic Separator.	Follow the procedures for <b>ADJUSTING THE 2" SBR 1/8" RUBBER BAND</b> and gradually cover the holes to reduce velocity. NOTE: If the abrasive media has changed since the first use of the sandblasting cabinet, contact a Kresco technician for proper adjustments.
	The seal around the large debris drawer is damaged or incorrectly installed.	Check the seal around the drawer to ensure it is airtight and replace it if necessary.
	The telescopic tube of the cyclone separator is not properly adjusted due to a change of abrasive or it is damaged.	Contact your Kresco technical representative <sup>2</sup> .
	There is a leak in the system or in the sandblasting pot.	Look for an air leak between the pressurized vessel and the storage hopper or cyclone system.

<sup>2</sup>The cyclone separator's telescopic tube is factory-set for the abrasive specified at the time of purchase. If the abrasive changes during use, it may be necessary to readjust the inner tube to modify the movement and airflow within the cyclone separator.

Type of failure	Possible cause	Resolution
Insufficient abrasive in the mixture (the nozzle is mainly blowing air)	There is no more abrasive media in the storage hopper for one of the following reasons: 1. The media turned to dust and was drawn by the dust collector. 2. An incorrect setting of the Cyclonic Separator caused all the media to be exhausted into the dust collector.	1. Follow the <b>ABRASIVE LOADING PROCEDURE</b> to properly add media to your recovery system. 2. Follow the resolution of the error "Abrasive media in good working condition ends up in the dust collector drum (velocity too high (cfm) in the Cyclonic Separator)" above.
	Incorrect adjustment of the media control valve (the opening is too closed, not allowing enough abrasive media into the mixture).	Refer to the sandblasting pot manual and follow the <b>MEDIA REGULATION VALVE ADJUSTMENT</b> procedure.
	Media control valve blockage.	Refer to the sandblast pot manual and disassemble the media regulating valve to isolate and resolve the obstruction.
	Restriction at the air supply connection (a quick-connect fitting or a fitting creating a restriction was used).	Review the <b>INSTALLATION AND START-UP</b> procedure and use only straight fittings as indicated in this manual.
	The compressor is unable to supply the compressed air required for the process.	Refer to the <b>WORKING AIR PRESSURE ADJUSTMENT / SUCTION SYSTEM AIR CONSUMPTION TABLE</b> procedure to ensure your compressor is able to supply the required air pressure and volume for your application.
	Large debris collection drawer partially or completely blocked	Turn off the recovery system to stop the dust collector turbine, open and empty the drawer of large debris.
Too much abrasive in the mixture (the sandblasting is unstable, jerky and uneven)	Incorrect adjustment of the media regulation valve (the opening is too large, allowing too much abrasive media into the mixture).	Refer to the sandblasting pot manual and follow the <b>MEDIA REGULATION VALVE ADJUSTMENT</b> procedure.

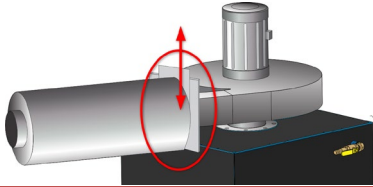
Type of failure	Possible cause	Resolution
<p>Abrasive material accumulates in the suction ducts. (particularly in the vertical rise bend). The air circulation velocity in the suction ducts is insufficient.</p>	<p>The cartridges are partially or completely blocked.</p> 	<p>Replace the cartridges.</p>
	<p>Poor adjustment of the exhaust flap located at the outlet of the dust collector fan.</p> 	<p>The hatch opening is factory-set according to the abrasive specified at the time of purchase. Its opening should only be adjusted when the abrasive is changed. Contact your Kresco representative to find the right fit for your application.</p>



## WARRANTY STATEMENT

**Kresco** warrants all equipment led in this manual which is manufactured by **Kresco** and bearing its name, to be free from defects in material and workmanship on the date of sale by an authorized **Kresco** distributor to the original purchaser for use. Notwithstanding any special, extended or limited warranty published by **Kresco** will, for a period of TWENTY-FOUR (24) months from the date of sale, repair or replace any part of the equipment determined by **Kresco** to be defective.

This warranty applies only when the equipment is installed, operated and maintained in accordance with **Kresco's** written recommendations. This warranty DOES NOT cover, and **Kresco** shall not be liable for general wear and tear, or any malfunction, damage or wear caused by faulty installation, misapplication, abrasion, corrosion, inadequate or improper maintenance, negligence, accident, tampering, or substitution of non-**Kresco** component parts. Nor shall **Kresco** be liable for malfunction, damage or wear caused by the incompatibility with **Kresco** equipment with structures, accessories, equipment or materials not supplied by **Kresco**, or the improper design, manufacture, installation, operation or maintenance of structures, accessories, equipment or materials not supplied by **Kresco**.

This warranty is conditioned upon the prepaid return of the equipment claimed to be defective to an authorized **Kresco** distributor for verification of the claimed defect. If the claimed defect is verified, **Kresco** will repair or replace free of charge any defective parts. The equipment will be returned to the original purchaser, transportation prepaid. If the inspection of the equipment does not disclose any defect in material or workmanship, repairs will be made at a reasonable charge, which charges may include the costs of parts, labor, and transportation.

THIS WARRANTY IS EXCLUSIVE, AND IS IN LIEU OF ANY OTHER WARRANTIES, EXPRESSED OR IMPLIED, INCLUDING BUT NOT LIMITED TO WARRANTY OF MERCHANTABILITY OR WARRANTY OF FITNESS FOR A PARTICULAR PURPOSE.

**Kresco's** sole obligation and the buyer's sole remedy for any breach of warranty shall be as set forth above.

The buyer agrees that no other remedy (including, but not limited to, incidental or consequential damages for lost profits, lost sales, injury to person or property, or any other incidental or consequential loss) shall be available. Any action for breach of warranty must be brought forward within two (2) years of the date of sale.

**Kresco** MAKES NO WARRANTY, AND DISCLAIMS ALL IMPLIED WARRANTIES OF MERCHANTABILITY AND FITNESS FOR A PARTICULAR PURPOSE, IN CONNECTION WITH ACCESSORIES, EQUIPMENT, MATERIALS OR COMPONENTS SOLD BUT NOT MANUFACTURED BY **Kresco**. These items sold, but not manufactured by **Kresco** (such as electric motors, switches, hose, etc.), are subject to the warranty, if any, of their manufacturer. **Kresco** will provide the purchaser with reasonable assistance in making any claim for breach of these warranties.

## LIMITATION OF LIABILITY

In no event will **Kresco** be liable for indirect, incidental, special or consequential damages resulting from **Kresco** supplying equipment hereunder, or the furnishing, performance, or use of any products or other goods sold hereto, whether due to a breach of contract, breach of warranty, the negligence of **Kresco**, or otherwise.

Report all accidents or "near misses" which involve **Kresco** products to:

- Kresco Technical Assistance at 1-877-757-3726

The following items are not covered under the **Kresco** warranty policy:

- Parts or chassis replacement due to normal wear
- Consumables and replacement parts (hoses, nozzle, gaskets, etc.)

Defective material or workmanship is not considered normal wear

## ABOUT KRESCO

**Kresco** designs, manufactures, and supports industrial equipment for the surface treatment industries. **Kresco** has standard equipment designed for most applications and can customize equipment to meet or exceed your production expectations.

## SANDBLASTING

- Sandblast Booths
- Sandblast Cabinets
- Automated Sandblasting Systems
- Abrasive Reclaiming Systems
- Pressurized Sandblasters
- Dust Collectors

## SHOT BLASTING

- Roller Conveyor Blaster
- Rotary Table Blaster/Swing Table Blaster
- Spinner Hanger (Batch)
- Continuous Flow with Monorail.
- Rubber and Steel Flight Tumbler Blasters
- Flow Thru Barrel Blasters
- Mesh Belt Continuous Blasters
- Monorail System Blasters
- Rim Blasters
- Preservation Line

## PAINTING & COATING

- Paint Spray Booths
- Powder Coating Booths
- Drying Ovens

## SOLVENT RECOVERY

- Batch Solvent Distillers
- Continuous Flow Solvent Distillers
- Oil Cooling Systems

## PARTS & CONSUMABLES

- Blast Nozzles
- Blast Hoses
- Abrasive Media (Glass Bead, Aluminum Oxide, Steel Shot and Grit)
- Air Valves
- Abrasive Metering Valves
- Cartridge Filters
- Sludge Bags
- Safety Equipment & PPE

## SERVICES

- Turnkey Project Design
- Custom Design
- Full Installation
- Start-up Supervision
- Training
- Maintenance
- Retrofit & Upgrade

All systems are designed to build and they are manufactured with the highest quality standards in our manufacturing shop in Quebec, Canada.